

Additional Data/Spec Sheet

82 Series – Low Pressure – Push-Lok Barb Fitting – Dual Flare SAE 45°/JIC 37° Female Swivel Straight

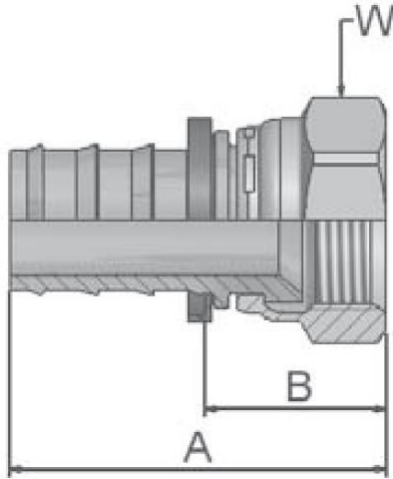

Self-grip Hose Fitting - BS5200-A – DKR – Brass Body



To be used with Push-Lok Hose or Equivalent Hose

Approved fitting series for hose types:



Fluidco and Parker 82 Series Part Number 	 Hose I.D.				 Thread UNF	A	B	W
	DN	Inch	Size	mm				
PL-JICFS-0404B 30682-4-4B	6	1/4	-4	6,3	7/16x20	39	19	9/16
PL-JICFS-0504B 30682-5-4B	6	1/4	-4	6,3	1/2x20	40	21	5/8
PL-JICFS-0604B 30682-6-4B	6	1/4	-4	6,3	9/16x18	42	22	11/16
PL-JICFS-0606B 30682-6-6B	10	3/8	-6	9,5	9/16x18	45	22	19
PL-JICFS-0608B 30682-8-6B	10	3/8	-6	9,5	3/4x16	47	24	7/8
PL-JICFS-0808B 30682-8-8B	12	1/2	-8	12,7	3/4x16	51	25	7/8
PL-JICFS-1008B 30682-10-8B	12	1/2	-8	12,7	7/8x14	52	25	1
PL-JICFS-1010B 30682-10-10B	16	5/8	-10	15,9	7/8x14	62	25	1
PL-JICFS-1212B 30682-12-12B	20	3/4	-12	19,1	1-1/16x12	67	30	1-1/4

Industry Applications:

Machine Tools, Paper Industry, Injection Moulding Machines, Chemical Industry, Transfer Lines, Automotive, Blow Forming Machines, Robots, Welding Installations, Power Electronics.

Main Applications:

Cooling and cutting fluid circuits, Water circuits for tool cooling and temperature control, Compressed air, Leak oil, Water, emulsions and alkalis, Vacuum, Welding gun cooling, Cooling circuits for thyristor controls

Benefits:

One fitting for all push-lok hoses, Simple assembly without tools or clamps, Long service life, Low assembly cost

Assembly Instructions



1. Cut the hose right angled with a sharp knife. If necessary it is possible to use a lubricant (water/ soap solution with 5 % soap fluid and 95 % water) for easy assembly.
2. Insert fitting into hose until first barb is in hose. Place end of fitting against a flat object (bench, door, wall) and grip hose approximately 1" from end and push with a steady force until end of hose is covered by yellow plastic collar. Alternatively please use the Parker Assembly Tool No. 611050G.

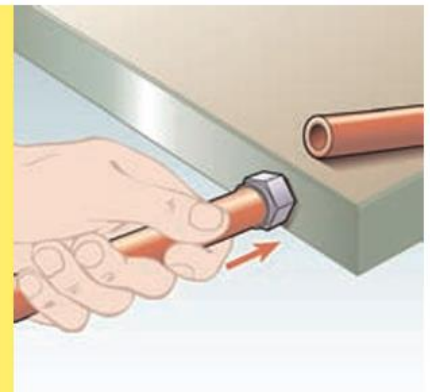

Attention!

During assembly, please keep in mind that Push-Lok fittings will provide an effective grip only when the Push-Lok hose is pushed fully on the insert, where the cropped end of the hose should be fully concealed by the plastic collar.

For easy assembly of hose 830M, 837BM and 837PU please use only Push-Lok Assembly Oil No. H896137. Push-Lok Assembly Oil is free from wetting disturbing substances. Don't use oil, lubricant or soap fluids for this hose!

Disassembly Instructions

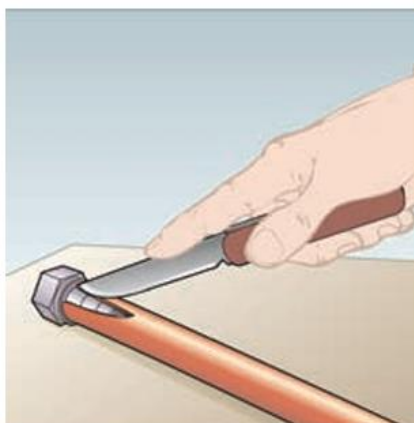

1. Cut lengthwise along a line at approximately a 20 angle from centre line of hose. The cut should be approximately 1" long. Be careful not to nick barbs when cutting the hose.
2. Grip hose and give a sharp down-ward tug to disengage from fitting.

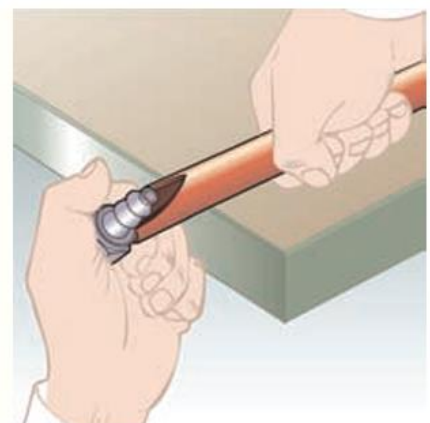

Attention!

Before re-use of the nipple please check nipple for damage. Damaged nipples can cause leakage.