

Additional Date/Spec Sheet

Group 1 XV-1P Vivoil Aluminium Gear Pumps – Italian Style – Clockwise but Rotation can be changed on request

CO001 Tapered 1:8 – Ø10 – M7x1 (10-8mm over 15mm) – 2.4mm Key

Body – Diamond Flange 30Pcd M6x1 Ports

Right
Rotation

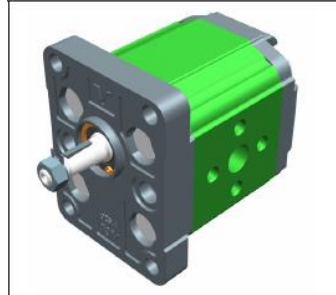
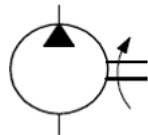

Reference XP101

Dimensions table										
TYPE	Weight	A	B	C	D	E	F	D	E	F
	kg	mm	mm	mm	IN			OUT		
XV-1P/3.8	1,120	88,5	42,5	76,5	ø12	30	M6x1	ø12	30	M6x1

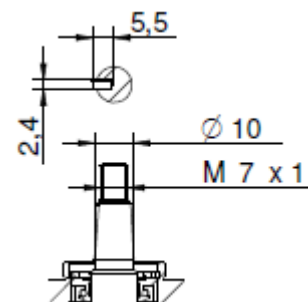
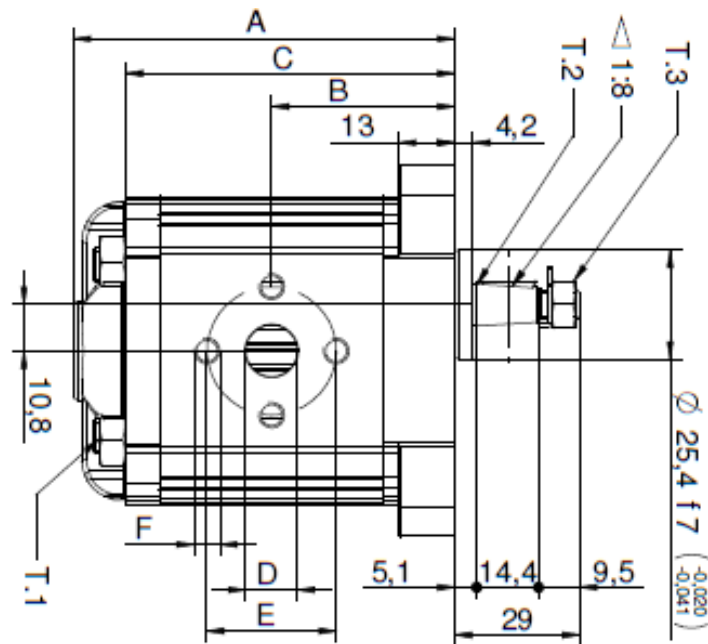
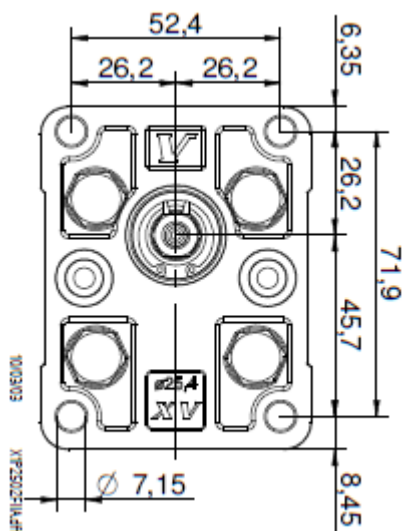
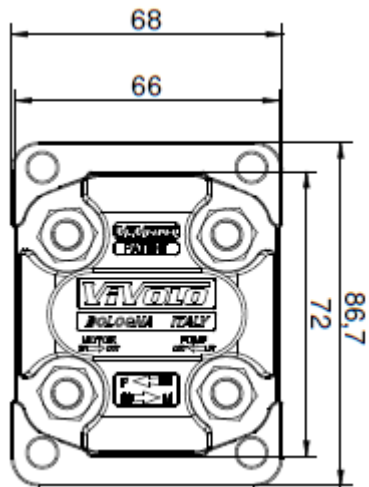

Summary: Displacements - Pressures - Speeds

Type	Displacement	Max. Pressure	Min speed	Max speed
XV-1P/0.9	0.91 cm ³ /rev	280 bar	700 rpm	6000 rpm
XV-1P/1.2	1.17 cm ³ /rev	290 bar	700 rpm	6000 rpm
XV-1P/1.7	1.56 cm ³ /rev	290 bar	700 rpm	6000 rpm
XV-1P/2.2	2.08 cm ³ /rev	290 bar	700 rpm	6000 rpm
XV-1P/2.6	2.60 cm ³ /rev	300 bar	700 rpm	6000 rpm
XV-1P/3.2	3.12 cm ³ /rev	300 bar	700 rpm	6000 rpm
XV-1P/3.8	3.64 cm ³ /rev	300 bar	700 rpm	6000 rpm
XV-1P/4.3	4.16 cm ³ /rev	300 bar	700 rpm	6000 rpm
XV-1P/4.9	4.94 cm ³ /rev	300 bar	700 rpm	6000 rpm
XV-1P/5.9	5.85 cm ³ /rev	300 bar	700 rpm	5000 rpm
XV-1P/6.5	6.50 cm ³ /rev	300 bar	700 rpm	5000 rpm
XV-1P/7.8	7.54 cm ³ /rev	260 bar	700 rpm	5000 rpm
XV-1P/9.8	9.88 cm ³ /rev	230 bar	700 rpm	4000 rpm

Technical data table							
TYPE	Displacement cm ³ /rev	Max. Pressure		CODE			
		P1 bar	P3 bar	Left rotation		Right rotation	
XV-1P/0.9	0,91	240	280	X 1 P 16 01	F I I A	X 1 P 16 02	F I I A
XV-1P/1.2	1,17	250	290	X 1 P 17 01	F I I A	X 1 P 17 02	F I I A
XV-1P/1.7	1,56	250	290	X 1 P 18 01	F I I A	X 1 P 18 02	F I I A
XV-1P/2.2	2,08	250	290	X 1 P 20 01	F I I A	X 1 P 20 02	F I I A
XV-1P/2.6	2,60	250	300	X 1 P 21 01	F I I A	X 1 P 21 02	F I I A
XV-1P/3.2	3,12	250	300	X 1 P 23 01	F I I A	X 1 P 23 02	F I I A
XV-1P/3.8	3,64	250	300	X 1 P 25 01	F I I A	X 1 P 25 02	F I I A
XV-1P/4.3	4,16	250	300	X 1 P 27 01	F I I A	X 1 P 27 02	F I I A
XV-1P/4.9	4,94	250	300	X 1 P 29 01	F I I A	X 1 P 29 02	F I I A
XV-1P/5.9	5,85	250	300	X 1 P 31 01	F I I A	X 1 P 31 02	F I I A
XV-1P/6.5	6,50	250	300	X 1 P 32 01	F I I A	X 1 P 32 02	F I I A
XV-1P/7.8	7,54	220	260	X 1 P 34 01	F I I A	X 1 P 34 02	F I I A
XV-1P/9.8	9,88	190	230	X 1 P 36 01	F I I A	X 1 P 36 02	F I I A

P1) Max. working pressure - P3) Max. peak pressure

For heavy-duty applications, it is recommended to check the admissible torque of the shaft

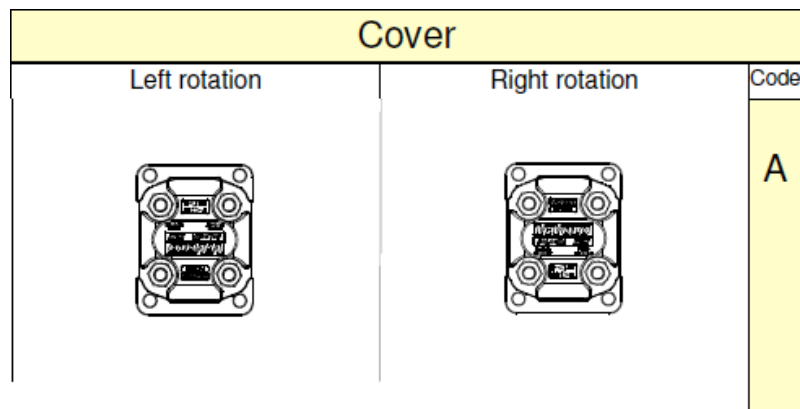
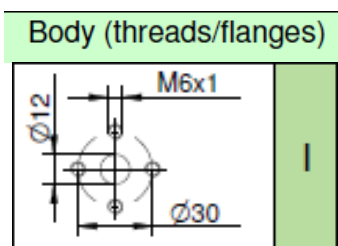

Flow rate tables

TYPE	cm ³ /rev	rpm											
		700	1000	1500	2000	2500	3000	3500	4000	4500	5000	5500	6000
XV 1P/0.9	0,91	0,630	0,900	1,350	1,800	2,250	2,700	3,150	3,600	4,050	4,500	4,950	5,400
XV 1P/1.2	1,17	0,840	1,200	1,800	2,400	3,000	3,600	4,200	4,800	5,400	6,000	6,600	7,200
XV 1P/1.7	1,56	1,190	1,700	2,550	3,400	4,250	5,100	5,950	6,800	7,650	8,500	9,350	10,200
XV 1P/2.2	2,08	1,540	2,200	3,300	4,400	5,500	6,600	7,700	8,800	9,900	11,000	12,100	13,200
XV 1P/2.6	2,6	1,820	2,600	3,900	5,200	6,500	7,800	9,100	10,400	11,700	13,000	14,300	15,600
XV 1P/3.2	3,12	2,240	3,200	4,800	6,400	8,000	9,600	11,200	12,800	14,400	16,000	17,600	19,200
XV 1P/3.8	3,64	2,660	3,800	5,700	7,600	9,500	11,400	13,300	15,200	17,100	19,000	20,900	22,800
XV 1P/4.3	4,16	3,010	4,300	6,450	8,600	10,750	12,900	15,050	17,200	19,350	21,500	23,650	25,800
XV 1P/4.9	4,94	3,430	4,900	7,350	9,800	12,250	14,700	17,150	19,600	22,050	24,500	26,950	29,400
XV 1P/5.9	5,85	4,130	5,900	8,850	11,800	14,750	17,700	20,650	23,600	26,550	29,500		
XV 1P/6.5	6,5	4,550	6,500	9,750	13,000	16,250	19,500	22,750	26,000	29,250	32,500		
XV 1P/7.8	7,54	5,460	7,800	11,700	15,600	19,500	23,400	27,300	31,200	35,100	39,000		
XV 1P/9.8	9,88	6,860	9,800	14,700	19,600	24,500	29,400	34,300	39,200				

XV-1P CHARACTERISTIC FLOW RATE CURVES

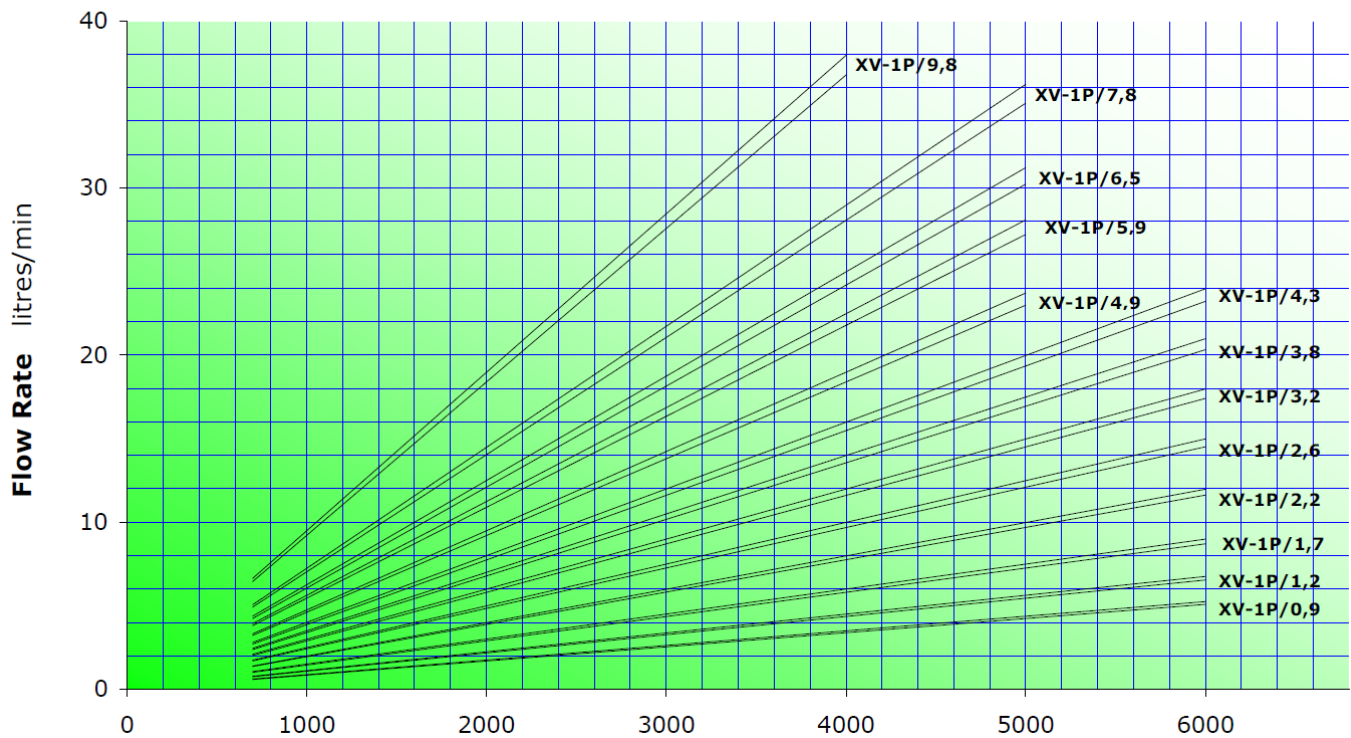

FORMULA FOR EVALUATING SHAFT	SHAFT [IDENTIFIER] - CODE - DESCRIPTION	T.2 [Nm]
$T.2 \leq \frac{v_i \times \Delta p}{20 \times \pi \times \eta m}$ <p>T.2 = max. torque allowed by shaft [Nm]</p>	[A] - CI001 - Parallel ø12 - M10x1 - key thk. 3	25,8
	[B] - CI002 - Parallel ø12.7 - key thk. 3.2 (SAE)	32,8
	[C] - CF001 - Milled shank ø10 - thk.5 ("BH" Standard German)	13,8
	[D] - CF002 - Milled shank ø10 - thk.5	13,8
	[E] - CF003 - Milled shank ø11 - thk.6.63 (SAE)	25,8
	[F] - CO001 - Tapered 1:8 - ø10 - M7x1 - key thk.2.4	43
	[G] - CO002 - Tapered 1:8 - ø14 - M10x1 - key thk.3	119,8
	[I] - CO004 - Tapered 1:8 - ø12.7 - 5/16" 24UNF-2A - key thk.3.2 (SAE)	90,4
	[J] - SCF04 - Splined ø11.7 - z=6, H=17.5, m=1.6, DIN 5482 12x9	22,6
	[K] - SCF05 - Splined ø12.344, z=9, H=19, SAE J498 9T 20/40DB	32,2
	[L] - SCF02 - Splined ø11.9, z=15, H=17.5, m=0.75	42,8
	[O] - CO002+HK - Tapered 1:8 - ø14 - M10x1, HK 14-12, key thk.3	119,8
	[P] - CI001+HK - Parallel ø12 - M10x1 with bearing HK 14-12 - key thk.3	25,8
	[Q] - SCF01 - Splined ø11.9, z=15, H=9, m=0.75	42,8
	[R] - SCF03 - Splined ø11.9, z=15, H=9, m=0.75	42,8

NOTES:

For assemblies with a coupling, you should choose one as balanced as possible in order to reduce the vibrations and dynamic stresses to which the pump shaft may be subject.

Always make sure that the torque applied is less than or equal to the admissible torque of the shaft.

Do not apply a direct axial or radial load on the pump shaft; if necessary, use suitable supports.

Always use well-filtered oils containing no water or other emulsifying substance.

Never run the pump with oil and air solutions.

For pumps with outlets on the flange, it is recommended not to exceed a flow rate of

20 l/min.	XV-1P
------------------	--------------

General technical data

Type of fluid to be used	Mineral-based hydraulic oil HLP HV (D IN 51524)
Minimum operating viscosity	10 mm ² /s
Maximum operating viscosity	100 mm ² /s
Maximum admissible viscosity at start-up	1500 mm ² /s
Recommended viscosity	20 mm ² /s - 100 mm ² /s
Ambient temperature	-20 °C - 60 °C
Fluid operating temperature	-15 °C - 80 °C
Recommended fluid operating temperature	30 °C - 50 °C
For temperatures above 120 °C	Request FKM seals (Viton)
Max. inlet fluid suction pressure (IN)	0.02-0.08 bars
Max. inlet fluid pressure (IN)	0.3 - 0.5 bars (for higher pressures consult the manufacturer)
Inlet fluid filtering (IN)	30 - 60 Microns
Outlet fluid filtering (OUT)	10 - 25 Microns
Max. inlet fluid speed (IN)	0.5 - 1.5 m/s
Max. outlet fluid speed (OUT)	3.0 - 5.5m/s
Use of water-glycol (HF-C)	max n. of revolutions 1100 rpm; max pressure 170 bars

XV1-P with Flange $\varnothing 25.4$ (ref. XP- 101)

When changing the direction of rotation of the XV-1P pump, it is not necessary to change the flange, as the same one is used.

When disassembling and reassembling the pump, take special care to ensure that seals and back-up rings do not come out of place and that no foreign bodies, such as shavings or dirt in general, get inside the pump.

<i>Flange $\varnothing 25,4$ (ref. XP- 101)</i>					
Remove the key, nut and washer from the shaft. Loosen and remove the fastening screws.	Take off the flange.	Take out the gears and upper bush. Warning!! The bush must never be turned.	Invert the positions of the driven and driving shafts. Warning! The body and cover must not be turned. Use the marking on the body as your reference.	Fit the previously removed flange back in place taking care to clean the body-base contact surfaces.	Replace the screws and tighten the nuts with a torque of 24.5 Nm to 29.4 Nm. Check that the shaft turns on completing the operation.
Note: with this rotation change system, the inlets and outlets remain unchanged.					

Useful calculation formulas

SYMBOL, UNIT OF MEASUREMENT, DESCRIPTION		
qv	l/min	Flow rate
vi	cm ³ /rev.	Displacement (volume of oil displaced per complete revolution of the shaft)
n	rpm	Shaft rotation speed
p1	bar	inlet pressure
p2	bar	outlet pressure
Δp	bar	Δp=p2 - p1 difference between outlet (OUT) and inlet (IN) pressure
Ph	kW	Hydraulic power delivered
Pm	kW	Mechanical power absorbed
T	Nm	Torque absorbed by shaft
ηv	-	0.91 – 0.96 volumetric efficiency (volumetric ratio between operation under load and loadless operation)
ηm	-	0.85 – 0.90 mechanical efficiency
ηt	-	ηt = ηv x ηm total efficiency

Basic Formulas	Derived Formulas	
$qv = \frac{vi \times n}{1000} \times \eta v$	$vi = \frac{qv \times 1000}{n \times \eta v}$	$n = \frac{qv \times 1000}{vi \times \eta v}$
$T = \frac{vi \times \Delta p}{20 \times \pi \times \eta m}$	$vi = \frac{T \times 20 \times \pi \times \eta m}{\Delta p}$	$\Delta p = \frac{T \times 20 \times \pi \times \eta m}{vi}$
$Ph = \frac{qv \times \Delta p}{600}$	$qv = \frac{Ph \times 600}{\Delta p}$	$\Delta p = \frac{Ph \times 600}{qv}$
$Pm = \frac{vi \times \Delta p \times n}{600000 \times \eta m}$	$vi = \frac{Pm \times 600000 \times \eta m}{\Delta p \times n}$	$\Delta p = \frac{600000 \times \eta m}{vi \times n}$

Constructive features

PART	MATERIAL	MECHANICAL FEATURES
PUMP BODY	Extruded alloy Series 7000, heat treated and anodised	Rp = 345 N/mm ² (Yield strength) Rm = 382 N/mm ² (Breaking strength)
FLANGE AND COVER	Die-cast aluminium alloy with excellent mechanical features, heat treated and anodised	Rp = 310÷350 N/mm ² (Yield strength) Rm = 350÷400 N/mm ² (Breaking strength)
GEAR BUSH BEARINGS	Special heat-treated tin alloy with excellent mechanical features and high anti-friction capacity. Self-lubricating bushes DU	Rp = 350 N/mm ² (Yield strength) Rm = 390 N/mm ² (Breaking strength)
GEARS	Steel UNI 7846	Rs = 980 N/mm ² (Yield strength) Rm = 1270÷1570 N/mm ² (Breaking strength)
SEALS	A 727 Standard Acrylonitrile F 975 Viton FKM	70 Shore, thermal resistance 120 °C 80 Shore, thermal resistance 200 °C
BACK-UP RINGS	Virgin PTFE Tecnil Q3	



Symbols of Vivoil Oleodinamica Vivolo products

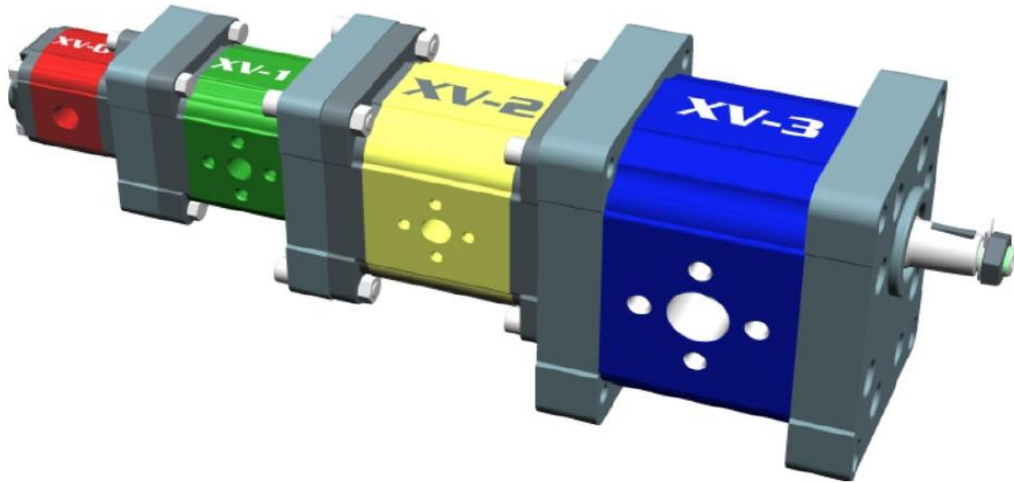

Unidirectional Pump

Left Rotation

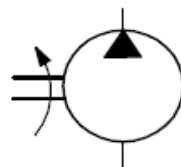

Right Rotation

