

Additional Data/Spec Sheet

NG6 Pressure Reducing Valve – Modular Type – Control Line Port P – Pressure Adj. Range 3-70Bar

MR*-01

Reducing Valves(Modular Type)

MOUNTING SURFACE:MR*-01-CETOP3
ISO 03-NFPAD03

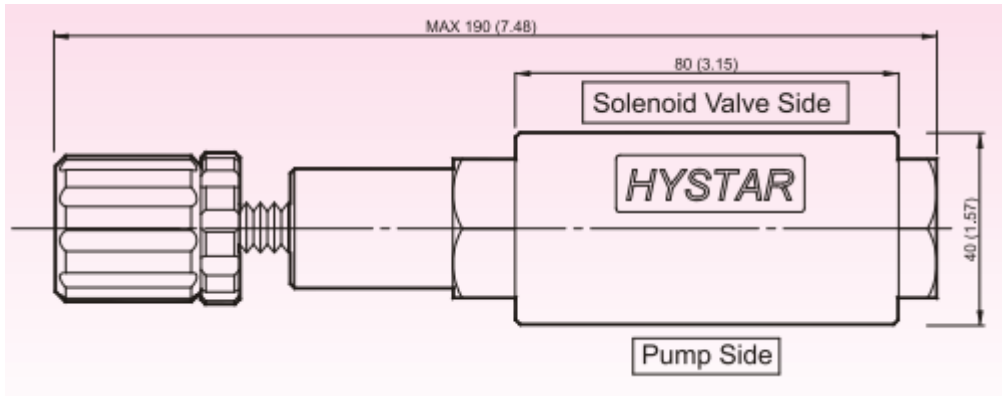
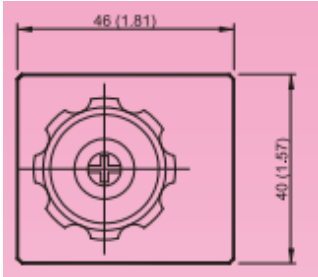
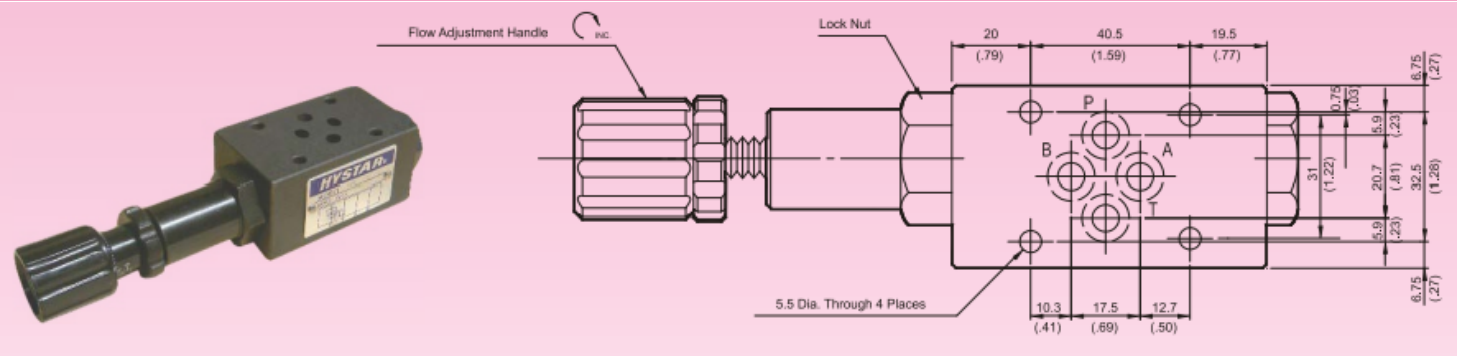

Valve Specifications & Attachment

Flow Rating	50 lpm (13.2 gpm)
Max. Pressure	250 bar (3600 psi)
Weight kg(lbs.)	1.1 (2.4)
CODE:20	M5 X85LgX4pcs
CODE:2090	10-24UNCX3-1/4"LgX4pcs
Mounting Surface O-Ring P9 x 4 pc	

