

Additional Information

For: Electronic Amplifier PC-Board HNC-1085

Terminal Connections

Electronic Amplifier Terminal Connections

Proportional Valve Solenoid

Input Control Voltage

Output Control Voltage

AC Supply Voltage

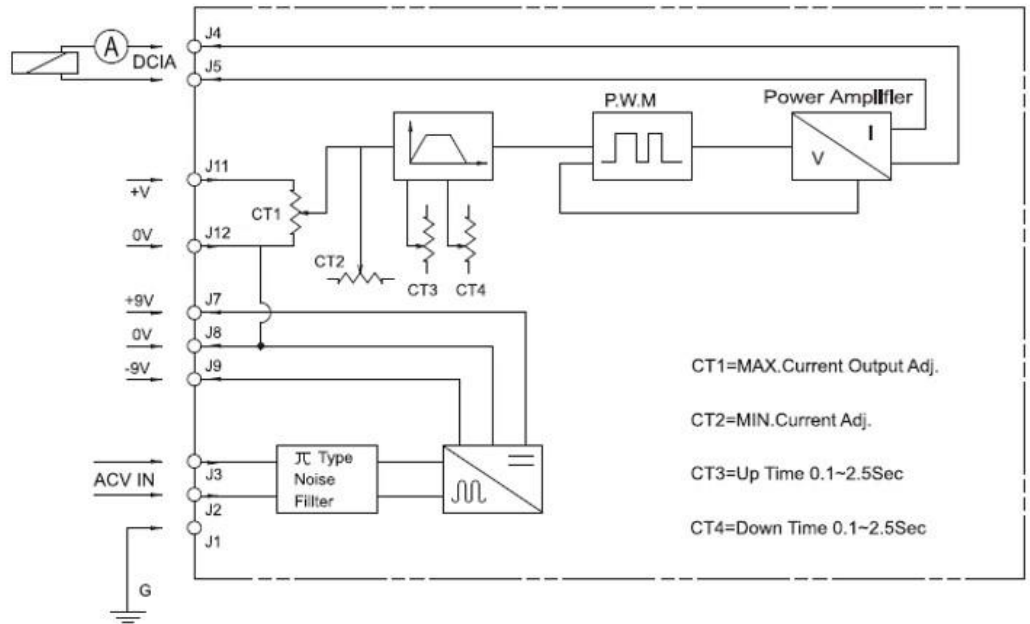

Installation Dimensions

P-C Board Dimensions

