

Additional Information

For: Dual Over Centre Valve 3/4"

Symbol Drawing:

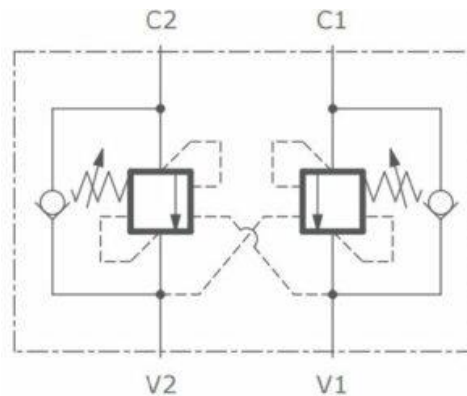

Application:

Over-center valve stops flow in one direction until pilot pressure is applied in the pilot port, then it opens.

In dual over-center valves, the pilot lines are internal.

Not as jerky as pilot check, works better for smooth load control. Should be adjusted to 30% above load pressure (wp)