

Additional Information

For: N/O 24V Line Mounting Solenoid Check Valve

Symbol Drawing:

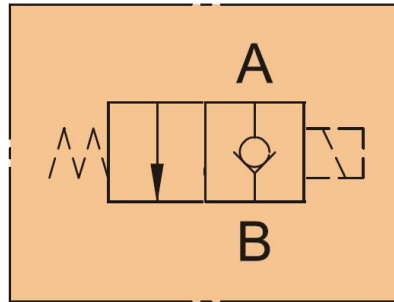

Installation Dimensions:

