

## Additional Information

### For: N/C 12V Line Mounting Solenoid Check Valve

#### Symbol Drawing:

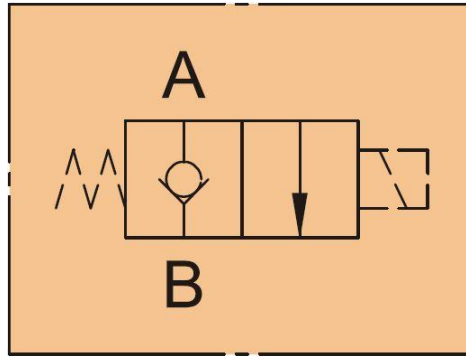

#### Installation Dimentions:

