

Additional Information

For: M45 5-Bank Lever Control Valve

Symbol Drawing for 1 Bank

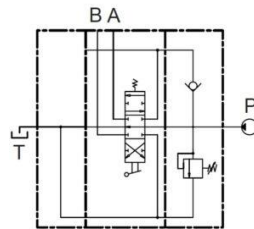

Symbol Drawing for 3 Bank

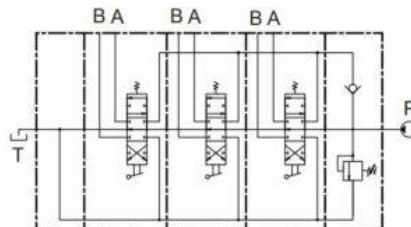

Single Bank Parts Drawing

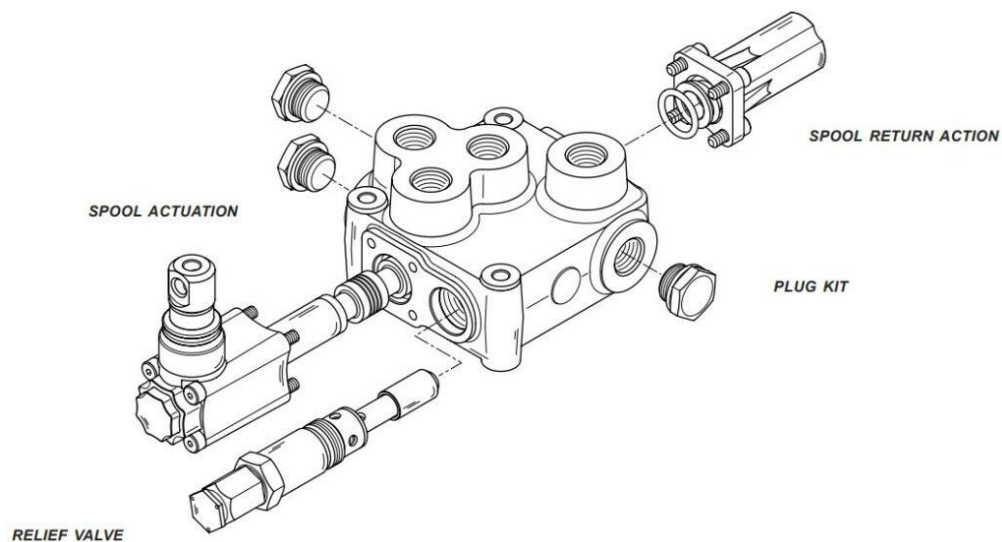

M45 Monoblock working sections - 1 to 6

Application

Numerous integrated valve features in addition to countless configuration options. The M45 series is highly flexible and easily adaptable to the widest of applications ranges. It offers the possibility to utilize a wide variety of interchangeable spools circuit. As well as different combinations between them. They have an solution to every requirement.