

## Additional Information

### For: Medium-Pressure 1/2" Ball Valve

#### Valve Composition

Body - Nickel Plated forged Brass  
End Adaptor - Nickel Plated Forged Brass  
Ball - Machined Brass Bar, Chrome Plated  
Ball Gasket - Pure Teflon  
Stem - Machined Brass Bar, Nickel Plated  
Red Handle - Zinc Plated, PVC Insulated  
Self-Locking Nut - Zinc Plated Steel

#### Installation Dimensions

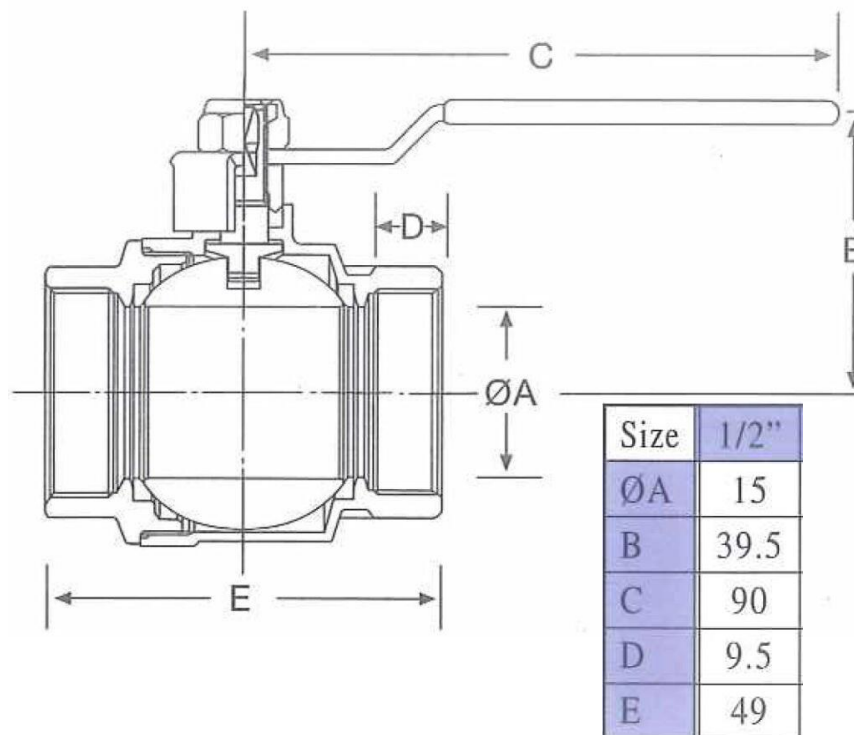

#### General Info

- Perfect Seal at low and high pressure
- Wear resistant, solid and long lasting material
- Rapid On/Off 90° turn operation
- Easy visual control of Open/Closed position
- -20°C to + 150°C
- Steel Handle
- Adjustable Gland
- Anti Blow out Stem