

Additional Information

For: Medium-Pressure 1/4" Ball Valve

Valve Composition

Body - Nickel Plated forged Brass
End Adaptor - Nickel Plated Forged Brass
Ball - Machined Brass Bar, Chrome Plated
Ball Gasket - Pure Teflon
Stem - Machined Brass Bar, Nickel Plated
Red Handle - Zinc Plated, PVC Insulated
Self-Locking Nut - Zinc Plated Steel

Installation Dimensions

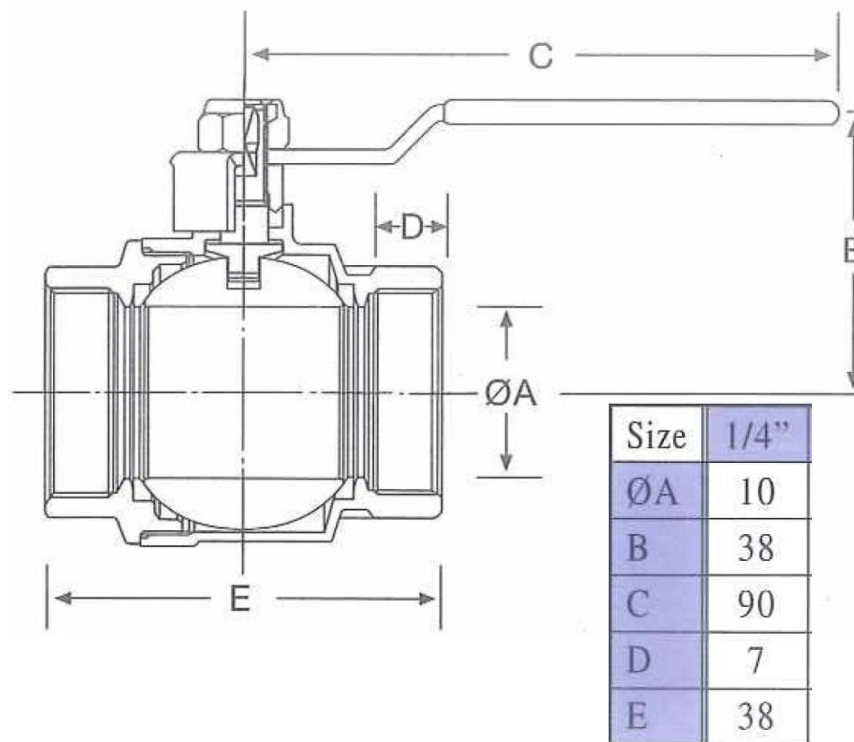

General Info

- Perfect Seal at low and high pressure
- Wear resistant, solid and long lasting material
- Rapid On/Off 90° turn operation
- Easy visual control of Open/Closed position
- -20°C to + 150°C
- Steel Handle
- Adjustable Gland
- Anti Blow out Stem