

Additional Information

For: Low-Pressure 3/8" Ball Valve

Valve Composition

Brass Chrome Plated Body
Brass Chrome Plated Ball
Blue Handle - Plastic coated Steel Chrome

Installation Dimensions

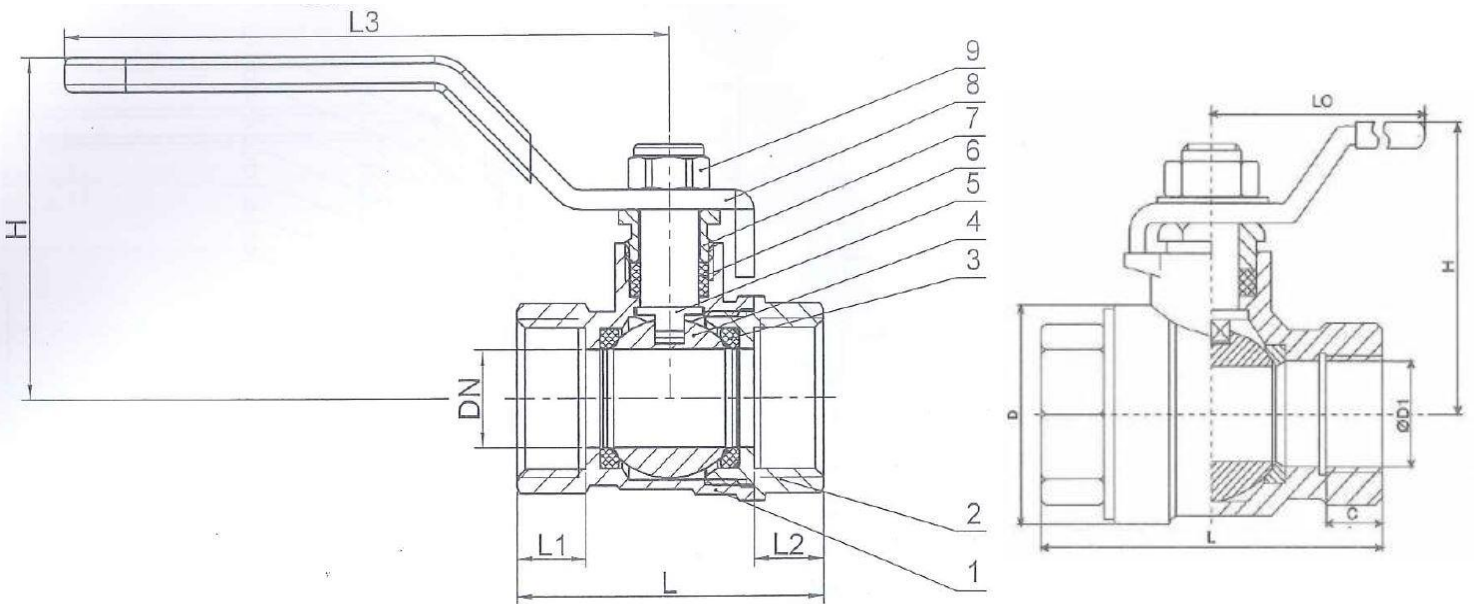

3/8	9	39	9	9	83	44	0.101
-----	---	----	---	---	----	----	-------