

Additional Information

For: 3/8" High-Pressure Ball Valves

Installation Dimensions & Symbol Drawing

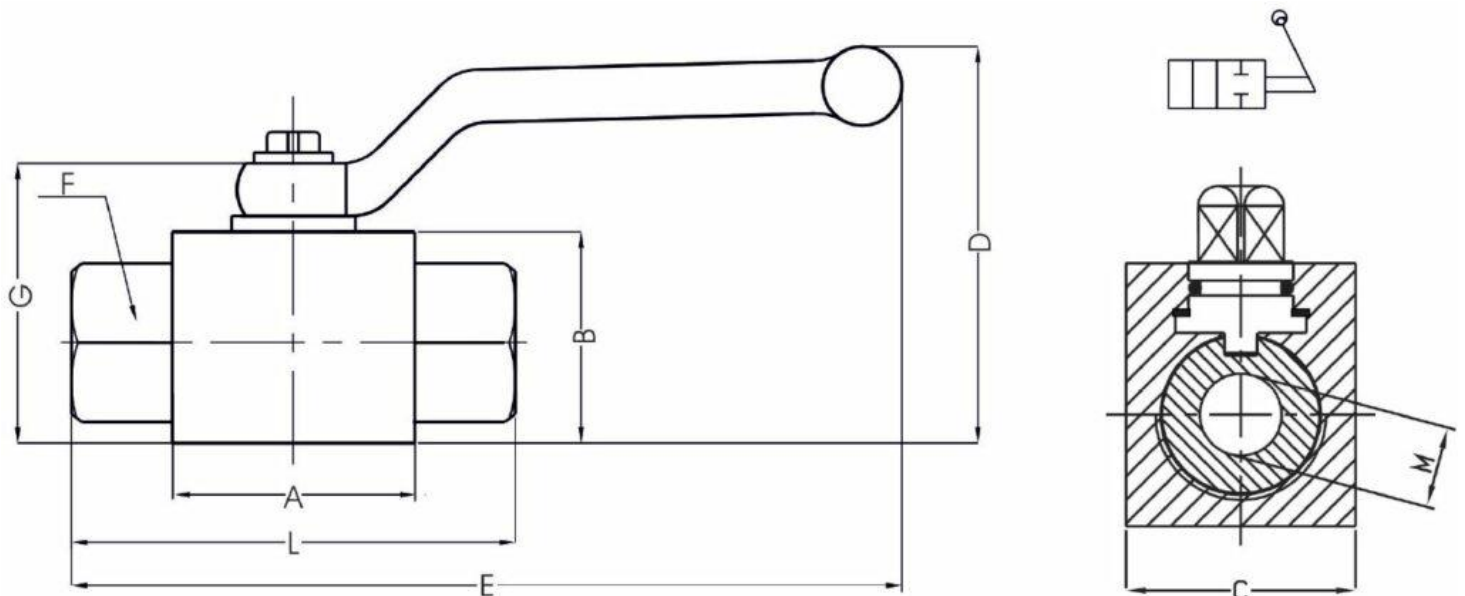

(Dimensions) - mm								
M	A	B	C	D	E	F	G	L
DN 10	45	35	30	75	150	24	48	75

Application

Excavators, plastic injection molding machines, chemical processing plants, cranes, tankers, dump trucks and general hydraulic applications

Additional General Info

BV2 Series Hydraulic 2 way Ball Valves are used to either shut off or open flow passage and their easy operation provides unrestricted flow. Due to their Volumetric structure they work rapidly and efficiently and prevent cavitation. BV2 Series Ball Valves can be locked in the open or closed position through locking washer on the circle pin. Internal ball is hard chrome coated steel and delrin (POM) seated. Ball Valves are suitable for LPG, CNG and other gas applications, as well as hydraulic and other industrial fluids.